



# SYSTEM 14

Design | Application | Specifications | Operation



# DESIGN & APPLICATION







## SYSTEM 14

Flexible and ergonomic

- Island or wall-fitted system
- Easy-to-clean system, fitted without legs
- Removable, modular unit systems
- Electric height-adjustable worktops
- Underbench cabinets/drawers can be moved from side to side without the use of tools
- Service bridge with free positioning of gas, water and air ventilation taps and fittings

System 14 is a very flexible and modular laboratory furniture system available with a range of different worktop materials, doors, hinges and handles.

The system ensures excellent ergonomics with height-adjustable worktops and moveable underbench cabinets. Island systems are also available with dual-access top cabinets.

The service bridge can be fitted with electrical sockets and fittings, which can be freely positioned along the entire length of the service bridge.





➤ POINT EXHAUST

➤ TOP CABINETS

➤ WORKTOPS

➤ SPLASHBACK

➤ UNDERBENCH CABINET  
AND DRAWERS

➤ WEIGHING COLUMN



[> SERVICE CHASE](#)

[> INSTALLATIONS](#)

[> TABLES](#)

[> SINK UNIT](#)



# Underbench cabinets and drawers

## SUSPENDED CABINETS

Suspended underbench cabinets available with laminate-coated fronts in the following variants:

- Door
- Drawers x 2
- Drawers x 2+1
- Drawers x 3
- Drawers x 4

## DRAWER SLIDES

Soft-close slides with 100% pull-out.

## HINGES

The self-holding, nickel plated hinge is visible from the outside. Opening angle of 270 degrees.

## HANDLES

Drawer and cabinet door handles are as standard, made from stainless steel with a width of 160 mm from centre to centre.



Hinge is visible from the outside

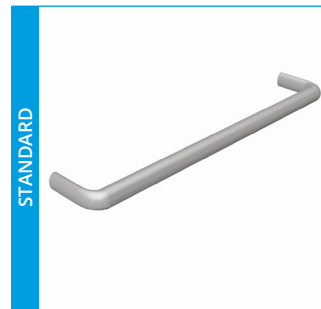

D-handle, acid-proof stainless steel (CTC: 160 mm)

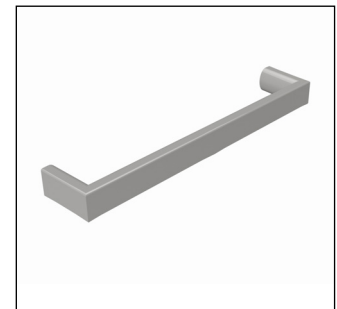

Handle, aluminium (CTC: 160 mm)

# Top cabinets

Top cabinets are available with laminate-coated doors or doors with glass panes with either a laminate or aluminium frame.



Mounting fitting for top cabinets



Wall cabinet with laminate-coated door

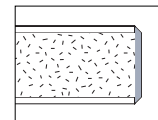

Pre-laminated edge band

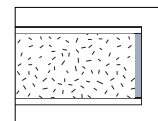

Post-laminated edge



Dual-access cabinet and glass door with aluminium frame



Dual-access cabinet with glass door and laminate frame with post-laminated edge



Wall cabinet with glass door and aluminium frame



Wall cabinet with glass door and laminated frame with post-laminated edge

# Tables

Worktops are available with height-adjust function as an option, with movement of 500 mm (750-1150 mm).



Stationary table



Height-adjustable table



Height-adjustable table (GMO)

# Worktops

## MATERIALS

- Laminate
- Compact laminate
- Polypropylene (PP)
- Stainless steel, 316
- Epoxy resin
- Ceramic



## WORKTOPS RESISTANCE OVERVIEW

	Organic solvent	Acid /Alka	Heat	Indentation	Impact	Discolouration	Surface unevenness	Absorption
Laminate	●	●	●	●	●	●	●●	●●
Compact laminate	●●	●	●	●●	●●	●●	●●●	●●
Polypropylene (PP)	●●●	●●●	●	●	●	●	●●●	●●
Stainless steel, 316	●●●	●●●	●●●	●●	●●●	●●●	●●●	●●●
Epoxy resin	●●●	●●●	●●	●●●	●●	●●●	●●●	●●●
Ceramic	●●●	●●●	●●●	●●●	●●	●●●	●●●	●●

Excellent ●●●    Good ●●    Acceptable ●

## COLOURS

### Laminate

STANDARD		OPTION					
White K100BS	Folkestone F7927Mat	Thistle F7880VEL	China Blue F7884VEL	Dusty Jade F7879VEL	Azur F1019Mat	Oceano K1997UN	Blu Violetto A0673ERRE

### Postshaped laminate

STANDARD	
White K100BS	Folkestone F7927Mat

### Compact laminate

STANDARD		OPTION	
White with black core FM0085FH	Grey with black core FM0074FH	Solid black FM0082FH	Solid white <i>Available only in 12 mm</i> FM0085



## Profiles, worktops

### LAMINATE



Straight front and rear edge.



Straight edges with pre-laminated ABS plastic edge band.



Post-formed front edge and straight rear edge.

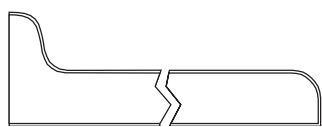

Post-formed front edge and grooved rear edge.



Post-formed front and rear edge.

*NB! The worktop must be assembled in the centre using the special fitting.*

### COMPACT LAMINATE



Bevelled edges.

### STAINLESS STEEL, 316



Straight front and rear edge.

## Profiles, sink unit worktops

### POLYPROPYLENE (PP)



All edges have raised edges.

### STAINLESS STEEL, 316



All edges have raised edges.

### EPOXY



All edges have raised edges.

### CERAMIC



All edges have raised edges.

### OPTIONS

Sink unit worktops are also available with laminate or as compact laminate. However, these worktops do not have raised edges.

Material <sup>1</sup>	Thickness	STANDARD		OPTION	
		Depth	Length <sup>2</sup>	Max. depth	Max. length
Laminate	30 mm	450 / 650 / 700 / 750 / 850 mm	600 / 900 / 1200 / 1500 / 1800 / 2100 mm	1297 mm	2597 mm
Compact laminate	16 mm	650 / 750 / 850 mm		1297 mm	2797 mm
Stainless steel, 316	30/35 mm	650 / 750 / 850 mm		3850 mm	1370 mm
Polypropylene (PP)	20/30 mm	650 / 750 / 850 mm		2000 mm	4000 mm
Epoxy	15/25 mm	650 / 750 / 850 mm		1500 mm	2900 mm
Ceramic	28/35 mm	650 / 750 / 850 mm		900 mm	1800 mm

<sup>1)</sup> Sink unit worktops are available with a depth of 650 mm and in the following lengths: 600, 900, 1200, 1500 and 1800 mm.

<sup>2)</sup> Worktops for island setups (D: 1500 / 1600 / 1700 mm) assembled in the centre using the special fitting.

If a worktop with a longer length than the stated maximum length is desired, then the worktop is assembled from the centre of the special fitting.

# Sink unit

The table below shows the combinations available when choosing the worktop type and sink.



## SINK UNITS

Worktop material	Glued sink	Inserted sink	All-welded sink	Sink, material
Laminate	STANDARD •	•		Stainless steel (304) / Polypropylene (PP)
Compact laminate	STANDARD •	•		Stainless steel (304) / Polypropylene (PP)
Stainless steel, 316			STANDARD •	Stainless steel (304/316)
Polypropylene (PP)			STANDARD •	Polypropylene (PP)
Epoxy	•	STD. •		Epoxy
Ceramic	STD. •	•		Ceramic

## SINK SPECIFICATIONS

Material	Standard dimensions	Optional dimensions	Bottom valve	Bottom strainer	Water trap	Overflow	Standpipe	Connection
Stainless steel, 304	480 x 340 x 145 mm	400 x 340 x 145 mm	•		•	•	OPTION	1 ½" CONNECTOR
Stainless steel, 304 (all-welded)	480 x 340 x 160 mm	500 x 400 x 160 mm 400 x 340 x 150 mm	•		•	•	OPTION	1 ½" CONNECTOR
Stainless steel, 316 (all-welded)	480 x 340 x 180 mm	500 x 400 x 200 mm 400 x 340 x 150 mm	•		•	•	OPTION	1 ½" CONNECTOR
Polypropylene (PP)	500 x 400 x 200 mm		OPTION	•	OPTION		•	1 ½" CONNECTOR
Epoxy	450 x 365 x 200 mm	406 x 305 x 203 mm 635 x 381 x 254 mm	OPTION	OPTION		OPTION	OPTION	1 ½" CONNECTOR
Ceramic	380 x 380 x 250 mm	530 x 380 x 250 mm	•		•		OPTION	1 ½" CONNECTOR

If you require more information, please contact Labflex.



# Service chase

The Labflex service chase is available either as wall-mounted or for island setups.

The hatch at the bottom of the service chase provides access for the laying and servicing of installations.

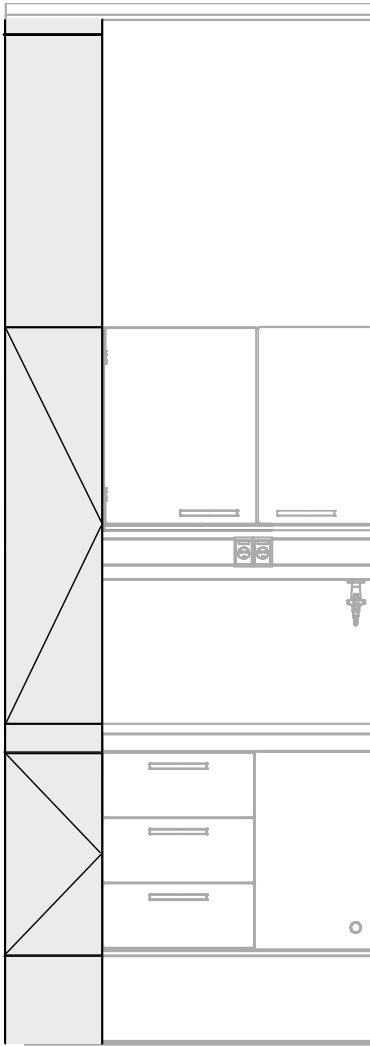

Cable and pipe laying from ceiling to floor

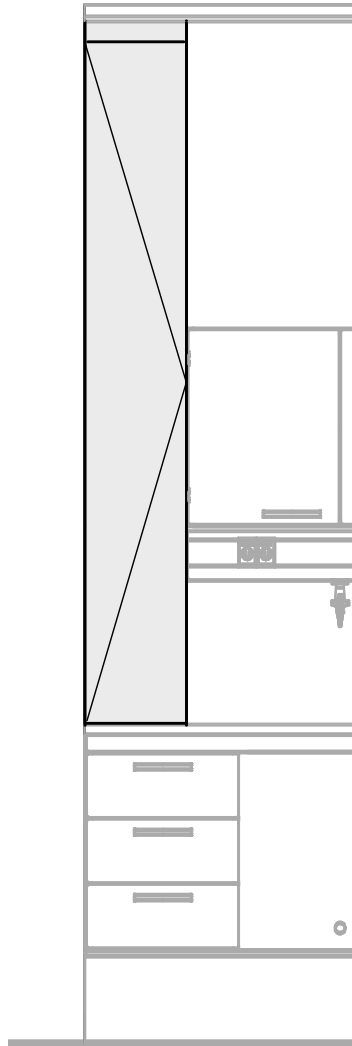

Cable and pipe laying from ceiling to unit

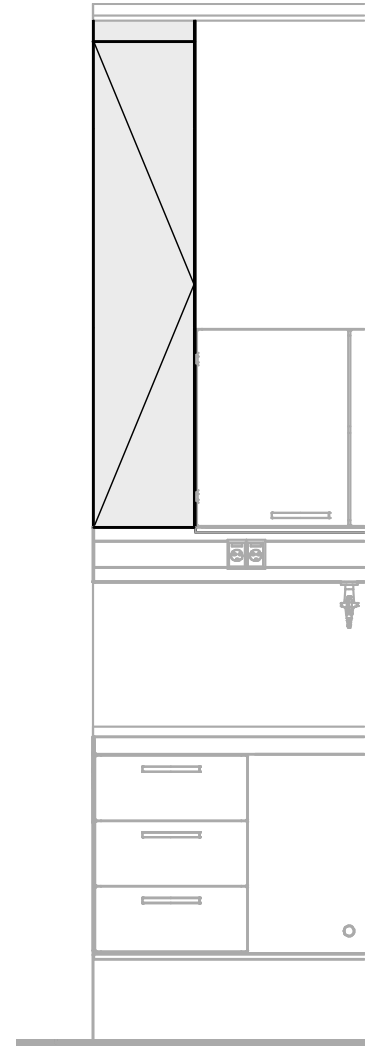

Cable and pipe laying from ceiling to service bridge

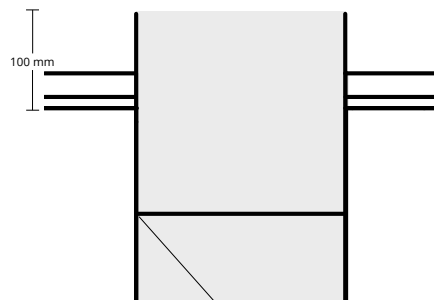

Continuous service chase

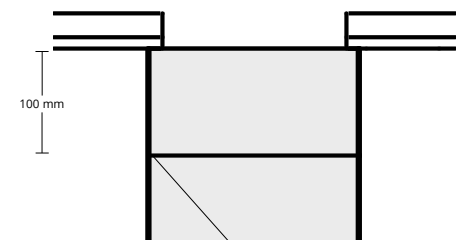

Service chase cut at ceiling edge

# Installations

## LIGHTING

LED printed circuit board for installation in the service bridge below the top cabinets.

- 4000 K
- Brightness: Minimum 1800 lm/m (brightness ~ 1600 lm, equivalent to a 100 W bulb)
- Minimum RA90
- Adjustable brightness, 100-10%.

Plug-and-Play solution: Only need to connect power. No need for external driver or damper.

## SERVICE BRIDGE SUSPENSION

Example of wall-mounted service bridge suspension

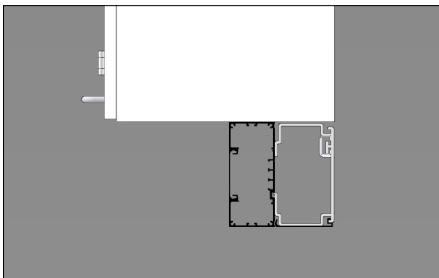
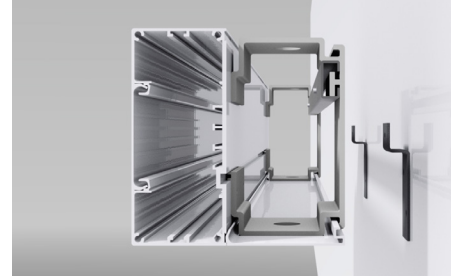

Wall-mounted service bridge without LED.

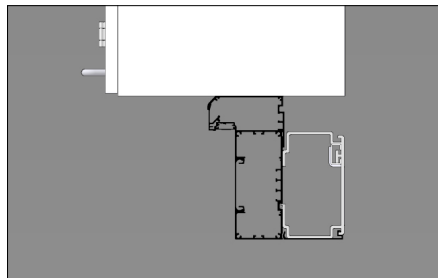

Wall-mounted service bridge with built-in LED.

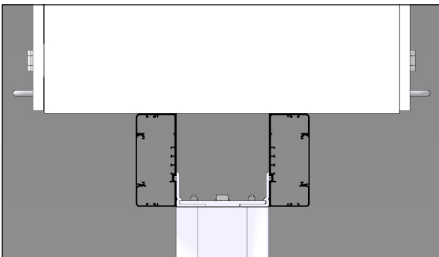

Standalone island setup and service bridge without LED.

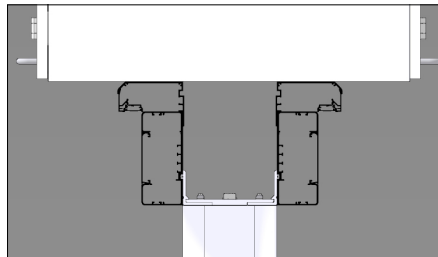

Standalone island setup and service bridge with built-in LED.

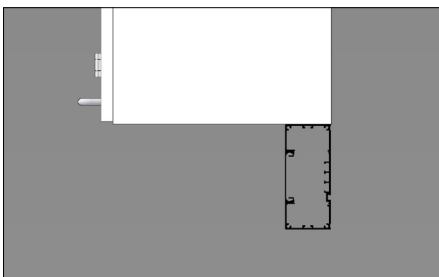

Wall-mounted electrical duct without LED.

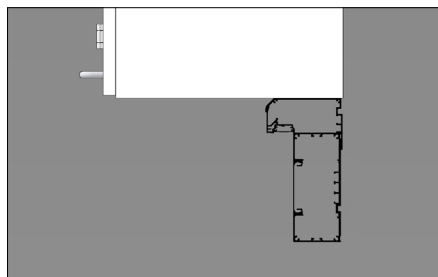

Wall-mounted electric duct with built-in LED.



# Installations

## ELECTRICITY

Electrical sockets are as standard, positioned flush with the service bridge.

### STANDARD



Single



Double



Triple

### OPTION



Single, SCHUKO



Double, SCHUKO



Triple, SCHUKO

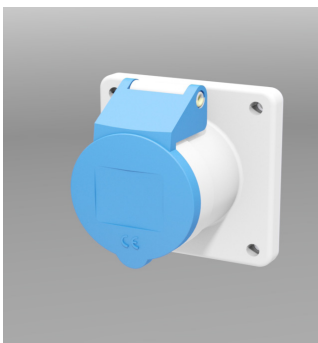

CEE 230 V

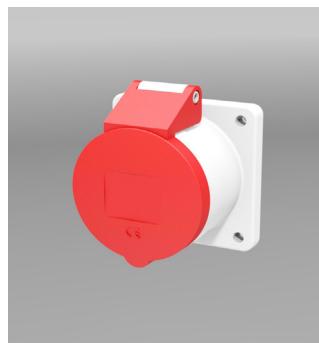

CEE 400 V

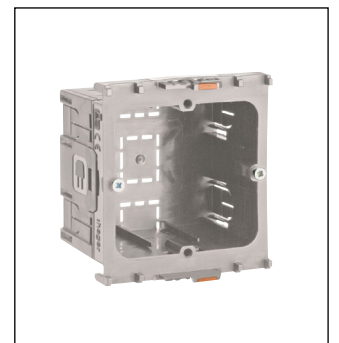

Empty back-box, OBO  
for fitting in duct



Frame for data/PDS

## Weighing column

The weighing column ensures optimal stability in order that precision measuring work can be executed in the laboratory. The weighing column is designed for precise measurements down to four decimal places, and its measuring is independent of the adjoining structure.

The weighing column's design includes vibration damping, and it can either be freely positioned or set in a worktop with a section cut out for the weighing column/weighing stone.

The weighing column's base plate is made from compact laminate and it is secured to the concrete floor using an expansion bolt. The weighing stone is made from granite.



## Point exhaust

The extraction arm is designed as a self-bearing and flexible structure, which is easy to operate and clean. The arm can be adjusted with one hand, so that it extracts smoke, dust or gas as close as possible to the source of contamination.

- The extraction arm is supplied as a front-mounted, wall-mounted or ceiling-mounted arm.
- The standard extraction arm does not have a damper (available as an option with manual damper).
- Extraction arm: Ø125 mm and L = 1000 mm.
- Extraction cup: Ø385 mm (polycarbonate).
- Rotatable 360 degrees (only when ceiling-mounted).
- Front-mounted is also available with detachable arm.



## Splashback

The splashback is made from 6 mm hardened glass and fitted on the sink unit to prevent splashes from the sink and taps.





# Taps

Labflex offers taps in different designs.  
The following pages will show which types Labflex offers as standard.



This design is shown on page 16.



This design is shown on page 17.

# Taps

Certified in accordance with ISO 9001 and Danish Gas Technology Centre (DG) approved. Colour codes on the handle are as standard in accordance with EN 13792.

## WATER

Labflex provides taps with a mixing tap or with separate hot and cold taps.



Single cold water tap

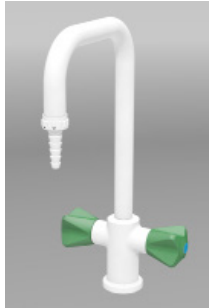

Separate hot and cold mixer tap



Single cold water tap with a wrist-action handle

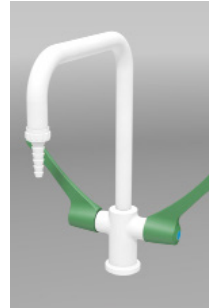

Mixer tap with two wrist-action handles



Single mixer tap

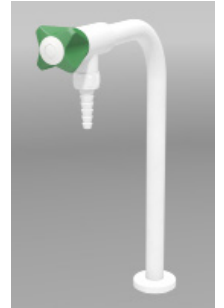

Single tap for distilled water

## GASES

Labflex provides as standard all purity variants and gas types.

Taps suspended from service bridge:



Single



Double



Single



Double

## EYE WASH

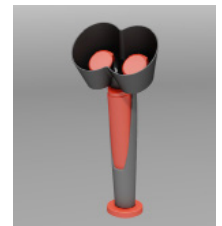

Fitted to worktop  
Two eyewash heads

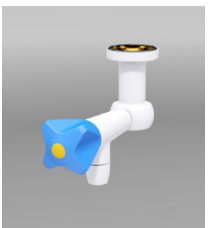

Single



Double



Single



Double

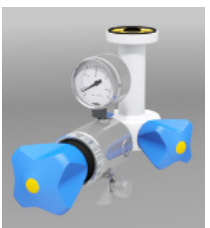

Single

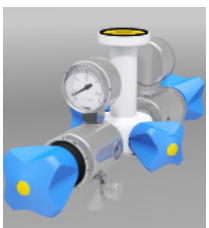

Double



Single



Double



Single

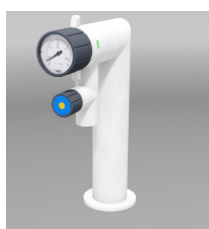

Single

# Taps

Certified in accordance with ISO 9001 and Danish Gas Technology Centre (DG) approved. Colour codes on the handle are as standard in accordance with EN 13792.

## WATER

Labflex provides taps with a mixing tap or with separate hot and cold taps.



Single cold water tap



Separate hot and cold mixer tap

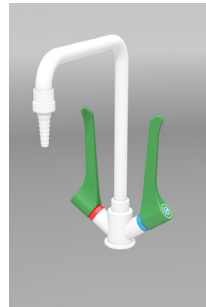

Mixer tap with two wrist-action handles



Single mixer tap



Single tap for distilled water

## GASES

Labflex provides as standard all purity variants and gas types.

Taps suspended from service bridge:



Single 2.0



Double 2.0



Single 2.0



Single 5.0



Double 5.0



Single 5.0 (Only compressed air)



Single 6.0



Single 6.0

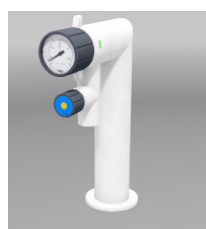

Single 6.0



Single 6.0

Worktop-mounted taps in service spine:

## EYE WASH



Fitted to worktop  
One eyewash heads

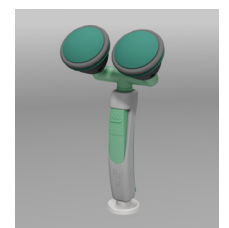

Fitted to worktop  
Two eyewash heads





lex  
aste choice





SPECIFICATIONS

OPERATION

# System 14: Island setup

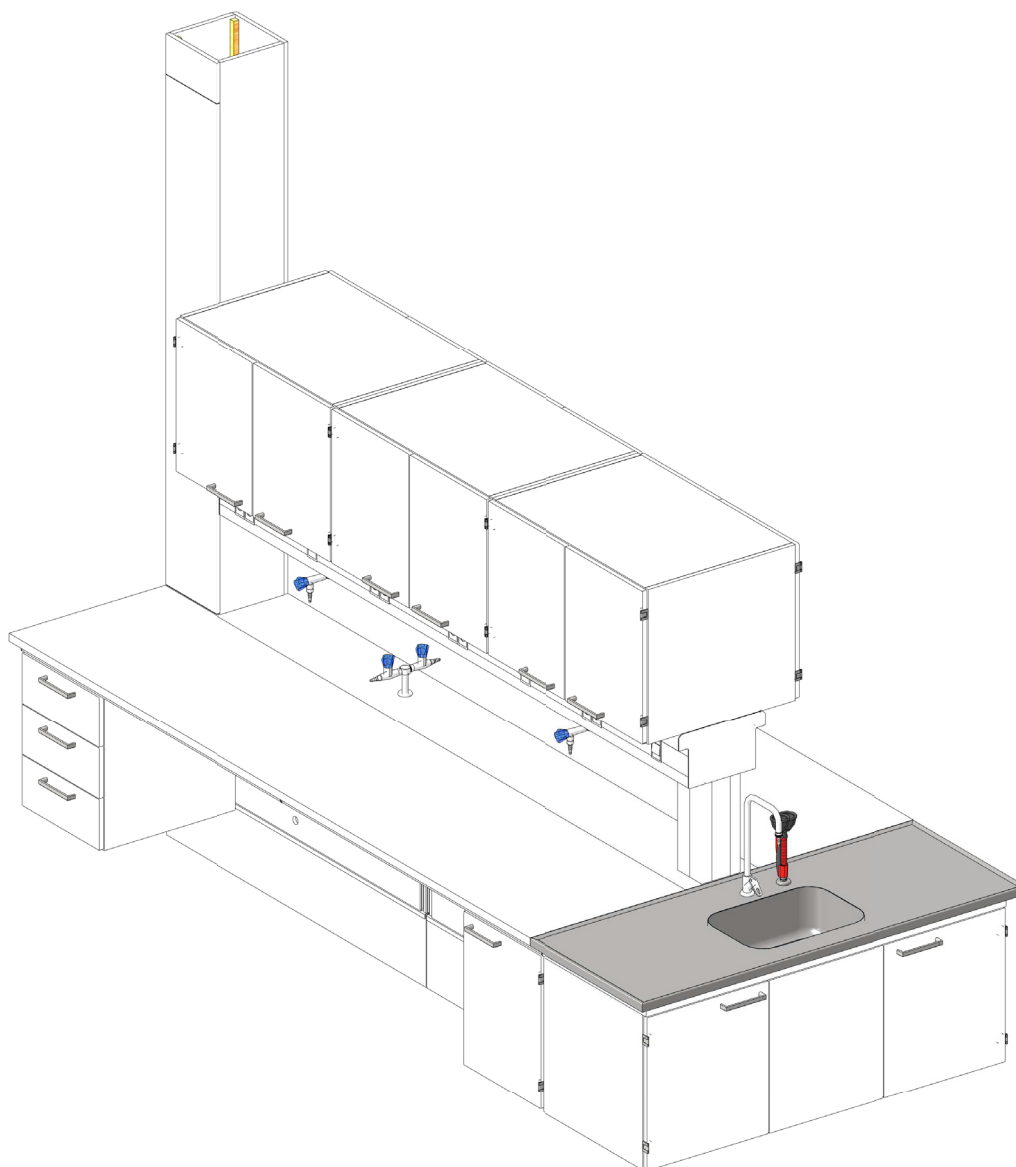

## CABINETS AND DRAWERS FOR ISLAND SETUP WIDTHS (in mm)

<b>Top cabinet (H: 600/780)*</b>	300	450	500	600	750	900	1000	
<b>Drawer cabinet, suspended (H: 450/600)**</b>		450	500	600	750	900	1000	
<b>Underbench cabinet, suspended (H: 600)*</b>		450	500	600	750	900	1000	
<b>Sink cabinet, suspended (H: 600)*</b>						885	1185	1485
<b>End sink cabinet (H: 600)</b>								1500

\* Cabinets with doors and widths greater than 600 mm are available with double doors. Sink cabinets are not moveable.

\*\* Drawer cabinets with H = 600 mm are available with 2, 3 or 4 drawers respectively, or with 2 + 1 drawers. Drawer cabinets with H = 450 mm are available with 2 drawers.

## WORKTOPS FOR ISLAND SETUP LENGTHS (in mm)

<b>Worktop</b>	600	900	1200	1500		1800	2100	2700	3000
<b>Worktop, height-adjustable</b>		900	1200	1500		1800			
<b>Sink worktop</b>	600	900	1200	1500		1800			
<b>End sink worktop</b>					1600				

With island setups, sink unit worktops can also be positioned in parallel on the service spine and are available in lengths up to 1800 mm.



# Plans and elevations

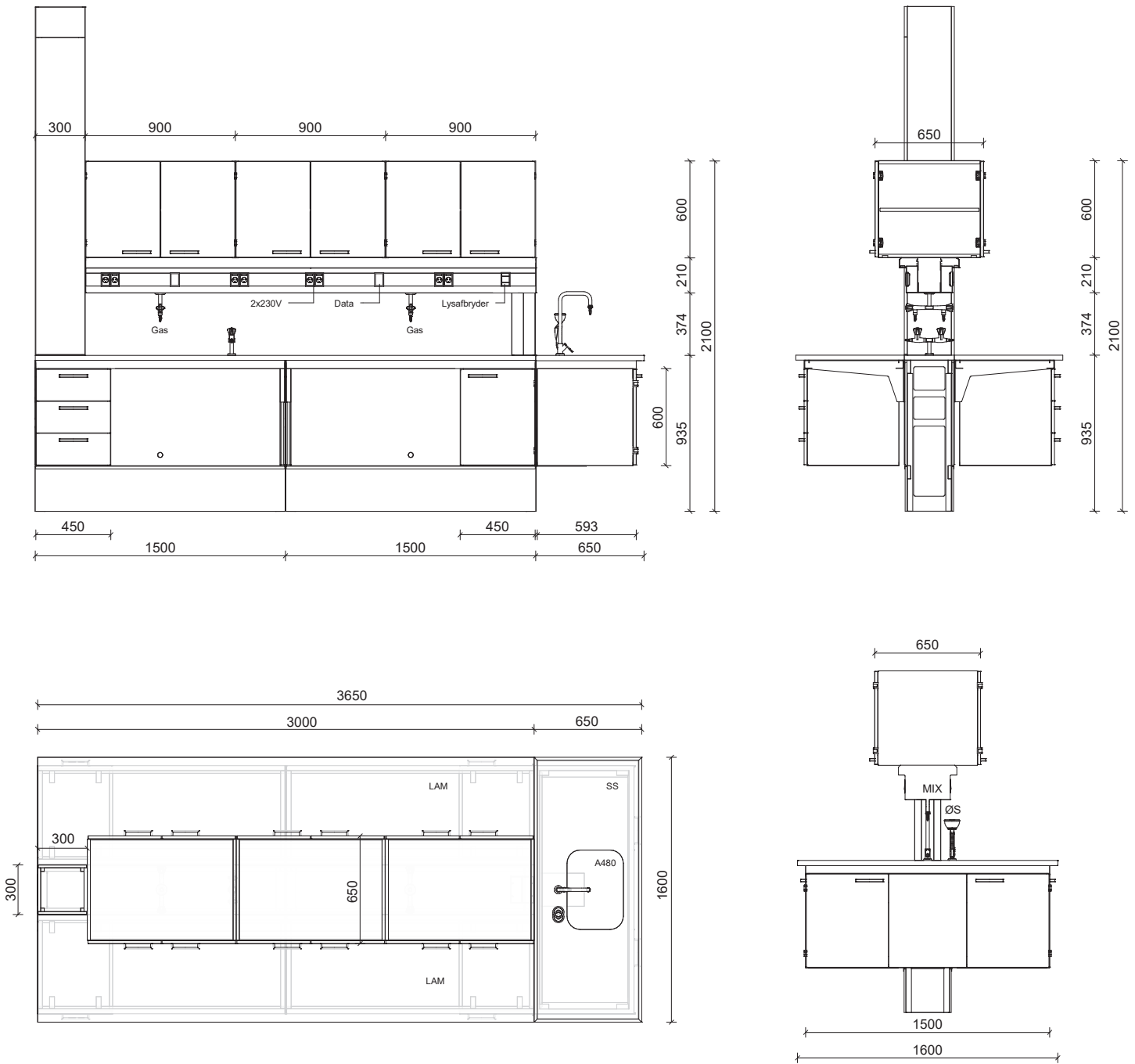

## ABBREVIATIONS

### Worktops

SS AISI 316 steel worktop with raised edges (T30 mm)

LAM Laminate worktop (T30 mm)

### Taps

MIX 1 x mixer tap per sink

ØS 1 x eyewash per sink

GAS 1 x gas outlet per workstation

### ELECTRICITY

2 x 230 V double socket per workstation

2 x empty double back-box incl. white frames per workstation

1 x light switch per position

### Sink

A480 Steel AISI 316 sink (W480 x D340 x H180 mm)

# System 14: Wall setup

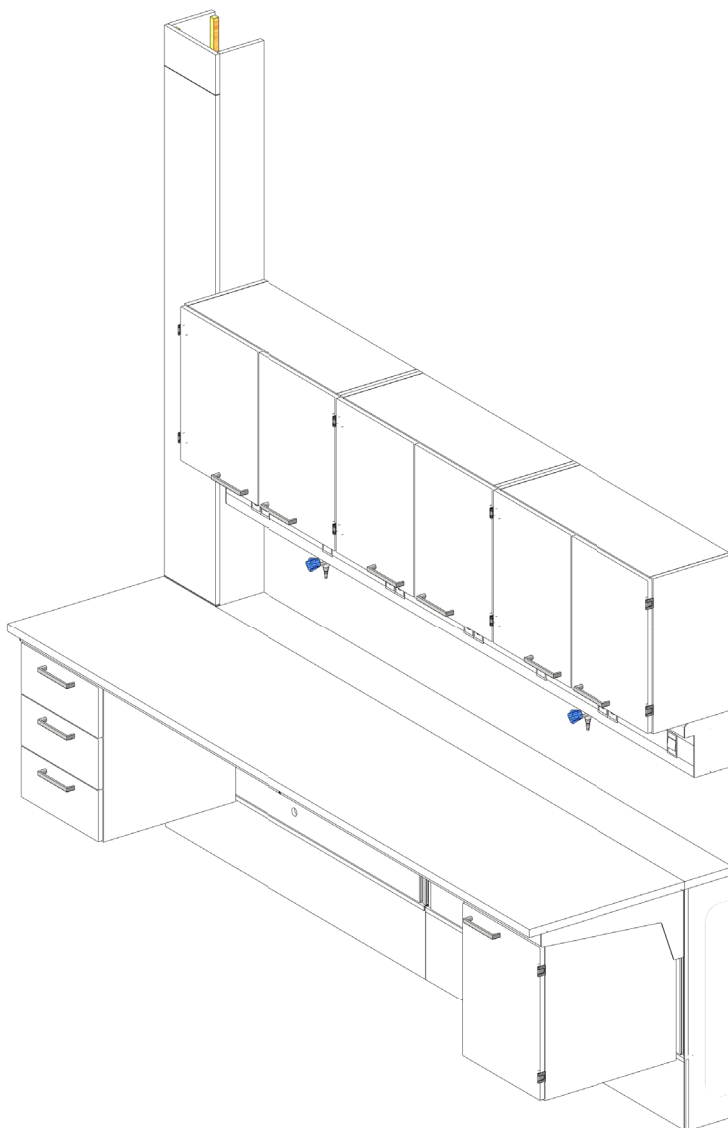

## CABINETS AND DRAWERS FOR WALL

### WIDTHS (mm)

	300	450	500	600	750	900	1000
<b>Top cabinet (H: 600/780)*</b>							
<b>Drawer cabinet, suspended (H: 450/600)**</b>							
<b>Underbench cabinet, suspended (H: 600)*</b>							
<b>Sink cabinet, suspended (H: 600)*</b>							

\* Cabinets with doors and widths greater than 600 mm are available with double doors.

\*\* Drawer cabinets with H = 600 mm are available with 2, 3 or 4 drawers respectively, or with 1+2 drawers. Drawer cabinets with H = 450 mm are available with 2 drawers.

## WORKTOPS FOR WALL

### LENGTHS (mm)

	600	900	1200	1500	1800	2100	2700	3000
<b>Worktop</b>								
<b>Worktop, height-adjustable</b>								
<b>Sink worktop</b>								

# Plans and Elevations

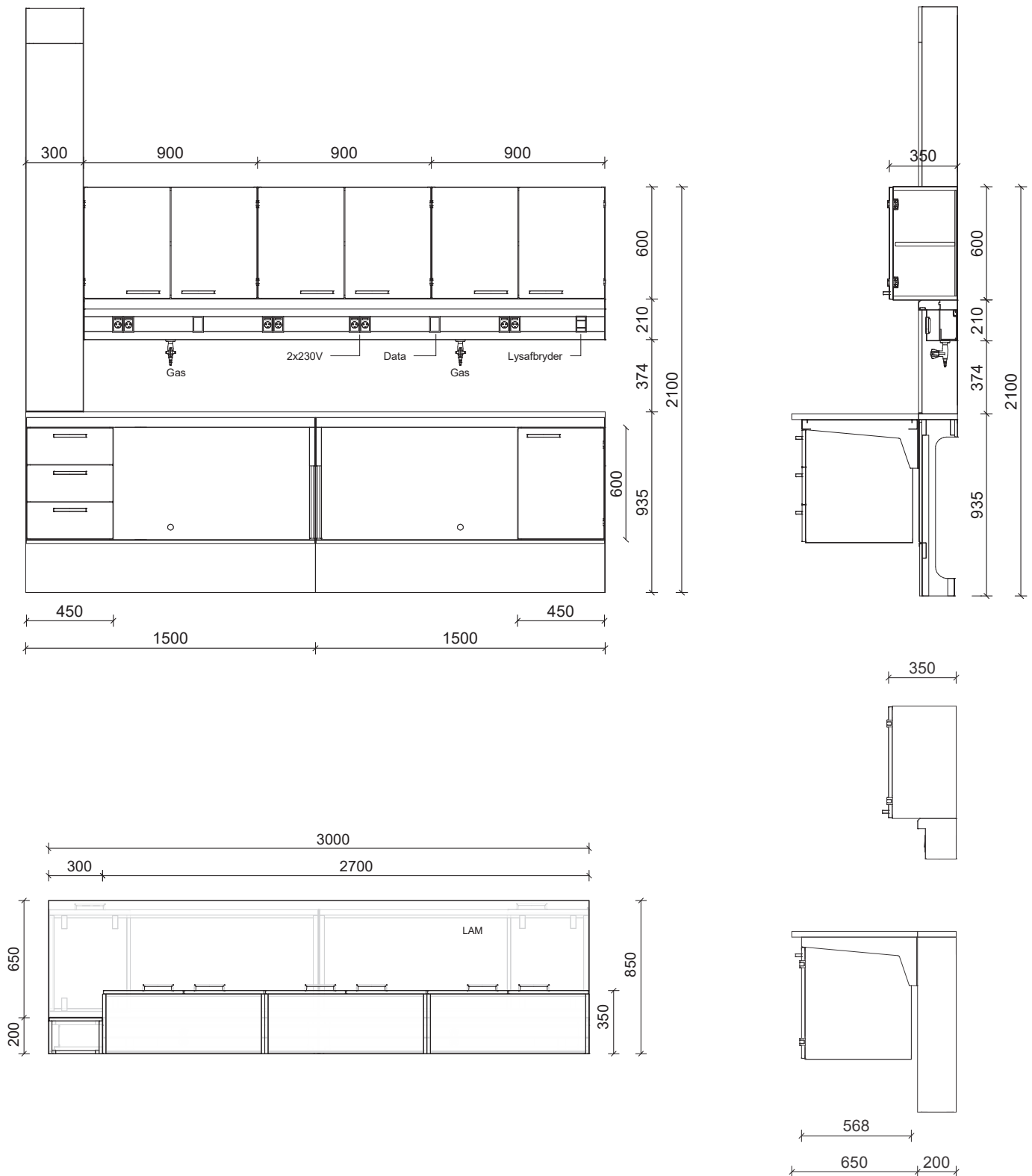

## ABBREVIATIONS

### Worktops

**LAM** Laminate worktop (T30 mm)

### Taps

**GAS** 1 x gas outlet per workstation

### ELECTRICITY

2 x 230 V double socket per workstation

2 x empty double back-box incl. white frames per workstation

1 x light switch per position



# Technical specifications

## TOP CABINET WITH DOORS

The cabinets consist of a carcass with a moveable shelf and doors.

The carcass and shelf are made from 19 mm melamine-coated panels. The doors are made from 19 mm laminate-coated chipboard with or without panes made from hardened glass with a frame made from either laminate or aluminium. The doors are supplied with a stainless steel handle as standard and have Labflex Omega hinges with an opening angle of 270 degrees.

The cabinets' rear lining is made from 6 mm melamine-coated MDF. All edges have a 1 mm ABS edge band. The cabinets are assembled using glue and dowels.

## DRAWER CABINETS AND UNDERBENCH CABINETS

The underbench cabinets consist of a moveable shelf and a single or double door. The drawer cabinets consist of a carcass with varying drawers. The carcass and shelf are made from 19 mm melamine-coated panels. Doors and drawers are made from 19 mm laminate-coated chipboard and have stainless steel handles. All of the cabinets have a bead ribbon band on the edges to act as a dust seal.

The cabinets' rear lining is made from 6 mm melamine-coated MDF. All edges have a 1 mm ABS edge band. The cabinets are assembled using glue and dowels. The cabinets are suspended in the support frame using a mounting bracket made from polyamide. The cabinets can be moved in parallel with the service bridge.

The drawers fully open on stainless steel sliding rails. Drawer sides are made from 19 mm laminate-coated chipboard, and drawer bases and rear sections are made from 16 mm melamine-coated chipboard. All visible edges have a glued-on 1 mm edge band made from ABS plastic.

## TALL CABINETS

Tall cabinets consist of a carcass and four moveable shelves made from 19 mm chipboard coated in 100 g white (RAL 9016) melamine. Their rear lining is made from 6 mm melamine-coated MDF.

All edges have a 1 mm ABS edge band. Front edges have an integrated dust-seal profile with bead ribbon. The cabinets are assembled using glue and dowels.

## DOORS

The laminate doors are made from 19 mm laminate-coated chipboard and have a stainless steel handle as standard and have Labflex Omega hinges with an opening angle of 270 degrees. All edges have a 1 mm ABS edge band.

Glass doors are supplied with 4 mm hardened glass and a frame made from 19 mm laminate-coated chipboard. The glass is secured on the rear using plastic beading that is easy to clean. All edges have a 1 mm ABS edge band.

## MODULE SIDES FOR BASKETS/TRAYS

Module sides are supplied in injection-moulded ABS and can be

used with standard tray/basket modules 600 x 400 mm and 400 x 300 mm.

## PLINTHS

Plinths are 100 mm in height and made from 18 mm plywood coated with dark grey laminate in colour NCS S 7502-B or white laminate in colour NCS S0503-G40Y.

Plinths are supplied as standard without adjustable feet.

## MOBILE UNITS

Underbench cabinet on wheels consist of a carcass with drawers or with a door and a moveable shelf. The carcass and shelf are made from 19 mm melamine-coated panels. Doors and drawers are made from 19 mm laminate-coated chipboard and have stainless steel handles. All of the cabinets have a bead ribbon band on the edges to act as a dust seal.

The drawers fully open on stainless steel sliding rails. Drawer sides are made from 19 mm laminate-coated chipboard, and drawer bases and rear sections are made from 16 mm melamine-coated chipboard.

The cabinets' rear lining is made from 6 mm melamine-coated MDF. All edges have a 1 mm ABS edge band. The cabinets are assembled using glue and dowels.

## WHEELS

Mobile units are fitted with four wheels made from polyamide with height 88 mm and Ø 75 mm. The two front wheels are fitted with a brake.

## SUPPORT FRAME (FOR FITTING WORKTOP ON TOP)

- An all-welded steel frame made from 037 DIN 2395A grade steel, which is powder coated with at least 80 µm coating.
- RAL 9016, gloss 80.

## HEIGHT-ADJUSTABLE TABLE WITH DL4 ACTUATOR

Steel frame made from 037 DIN 2395A grade steel, which is powder coated with at least 80 µm coating. RAL 9016, gloss 80. The frame is fitted to two actuators, which are fixed to the bracket that secures the table to the panel structure.

The actuators also have a control box.

## ACTUATOR/LIFTING COLUMN DL4

The actuator has a three-part inline design, which means the motor is hidden in the profiles. The three-part design provides a low built-in dimension, thus ensuring the table can be adjusted in height.

The actuator has a movement of 500 mm (750–1150 mm).

- Max. height: 1150 mm (top of worktop)
- Min. height: 750 mm
- Powder-coated white RAL 9016
- External dimensions of rectangular profiles: 58 x 109.5 mm
- Max. power: 700 N per column
- Max. speed: 43 mm/s
- Low noise level

# Technical specifications

## END SINK UNIT

The end sink unit consists of a cabinet made from 19 mm white laminate-coated panels, doors and a stainless steel handle. Sink unit worktops have raised edges on all edges.

## WEIGHING COLUMN

The weighing column consists of a granite weighing stone, which is fixed to a panel made from black compact laminate. The panel is fitted into an aluminium column, which has a black compact laminate washer in the bottom and a steel expansion bolt.

## SPLASHBACK

Hardened glass is 4–6 times stronger than standard glass and granulates into small blunt pieces if broken. These small blunt granules are the reason why hardened glass is categorised as a safety glass. Hardened glass also has high heat resistance, of up to approx. 200° C.

## JOINTS

Wet room silicone 512 is a neutral, highly elastic sealant. It hardens in reaction to the air humidity and forms an elastic joint that can absorb movements of up to 25%.

- Skin formation: approx. 5-15 minutes at 23 °C and 50% relative air humidity.
- Curing: 1–2 mm/24 hours at 23 °C and 50% relative air humidity.

## LIFETIME

Labflex products are supplied with a product and repeat-order guarantee. Labflex provides a service concept, which consists of the following services:

- Installation
- Installation test
- Training
- Inspection and maintenance
- Advice

Labflex always provides servicing that is in accordance with the applicable standards, for example our fume cupboard servicing is in accordance with DS 457 and EN 14175.

## SUSTAINABILITY

Labflex collaborates with the Forest Stewardship Council (FSC). An FSC-certified forest guarantees that the number of trees that are felled in a forest never exceeds the forest's regenerative capacity. This collaboration enables sustainable production.

## QUALITY/CERTIFICATES

All taps are certified in accordance with ISO 9001 and approved by the Danish Gas Technology Centre (DG).

## LOAD-BEARING CAPACITY AND BENDING

Worktops, cabinets, drawers and shelves have different load-bearing capacities, depending on various factors such as dimensions, choice of material, loads, building conditions, etc.

Contact Labflex for more specific information about load-bearing capacity and maximum loads for the individual furniture solution.

## COLOUR CODES

Colour coding for taps are as standard in accordance with EN 13792. Labflex components are made from melamine, laminate and compact laminate, and as standard are in the colour RAL 9016. All steel components are in the colour RAL 9016, gloss 80.

# Technical specifications

## SERVICE CHASE

Service chases have white melamine sides and an access hatch for servicing and installation of hoses and pipe routing. When connecting from the ceiling or floor, the elements are routed via a duct to their tap outlet. The tap can be positioned either in the service bridge, under the cabinets or in the service spine.

If the tap outlet is to be installed in a service bridge, and the connection is from the floor, the hoses will run inside the service spine and up through the leg that holds the service bridge in position. If the connection is from the ceiling, the service chase is used to hide hoses and pipework. If the tap outlet is installed in the service spine, the connection from the floor will run directly up to the service spine's top plate, where the connection through the service chase will be run directly to the service spine and up at the centre of the worktop.

## SERVICE BRIDGES

The service bridge is executed using electric ducts made from extruded aluminium, which are powder coated in white RAL 9016 with a coating that is at least 80 µm. The service bridge functions as a supporting element for top cabinets with an island system with interior pipes and cable connections to electrical sockets, gas and water taps. Cables are as standard placed in casing pipes in accordance with the safety requirements on the separation of electricity and other media. The taps are fitted suspended in the service bridge.

## SERVICE SPINES

The service spines are supplied in the dimensions:

- Panel depth: 200 / 300 mm
- Panel height: 713 / 905 mm with stationary tables
- Panel height: 905 mm with height-adjustable tables

The panels are sealed in the end with gable end panels. Gable ends and sides on the service spine are made from machined 037 DIN 2395A grade steel, which is powder coated with a coating of at least 80 µm in white RAL 9016.

The taps can be positioned in the top panel and servicing of the pipe and cable connections can be carried out via the service spine's removable front panel. The base plate is made from laminate-coated water-repellent plywood. Service spines for height-adjustable tables are equipped with electrical sockets in the base plate.

The service spine must be secured to the concrete floor.

## INSTALLATIONS

### Lighting

The service bridge can be supplied with an LED printed circuit board for installation under top cabinets:

- 4000 K, MacAdam 3
- 19 W/m LED printed circuit board
- Minimum RA90

- External power supply/control box
- DALI and 1–10 V compatible in relation to dimming
- Dimmer unit 1–10 V: 100–10%.

There is light along the entire length of the fitting (at each end there is only 40–50 mm that is not illuminated).

## ELECTRICITY

- All electrical sockets are as standard classified IP20
- Cable thickness: 1.5 mm<sup>2</sup>
- 230 V / 16 A
- Type: DK or SCHUKO
- Marking of positioning: Dymo or engraving.

## Gas, water and air

Gas, water and air taps are integrated in the service bridge. All taps meet the requirements of the applicable norms and standards.

Colour coding of taps is in accordance with EN 13792.

All types of gas, water and air taps are supplied as standard with flex pipe/flex hoses.

## Technical gasses 2.0

- Max. pressure: 16 bar / 232 psi.  
Open/close turning function: 3 x 360 degrees.

## Vacuum

- Pressure for vacuum: 1–16 bar / 14.5–232 psi.  
Open/close turning function: 1.5 x 360 degrees.

## Pure gasses 5.0

- Max. pressure: 21 bar / 305 psi.  
Microflow top part: 7.5 x 360 degrees.
- Max. pressure: 21 bar / 305 psi.  
High flow top part: 1.5 x 360 degrees.
- Max. pressure: 21 bar / 305 psi.  
Needle top part: 3 x 360 grader (fine regulation).

## Pure gasses 6.0

- Max. pressure brass: 21 bar / 305 psi.  
Open/close turning function: 1.5 x 360 degrees.
- Max. pressure stainless steel: 16 bar / 232 psi.  
Open/close turning function: 1.5 x 360 degrees.

## Flammable gasses

- Max. working pressure: 7 bar / 102 psi.  
Pressure/turn function: 90 degrees.

The owner/user is responsible for the use and maintenance of the gas installation. It is recommended that every year the gas installation is checked for leaks, fixed gas appliances are checked for combustion, and hoses and pipes are inspected.

# Interfaces

## PIPE LAYING FROM CEILING

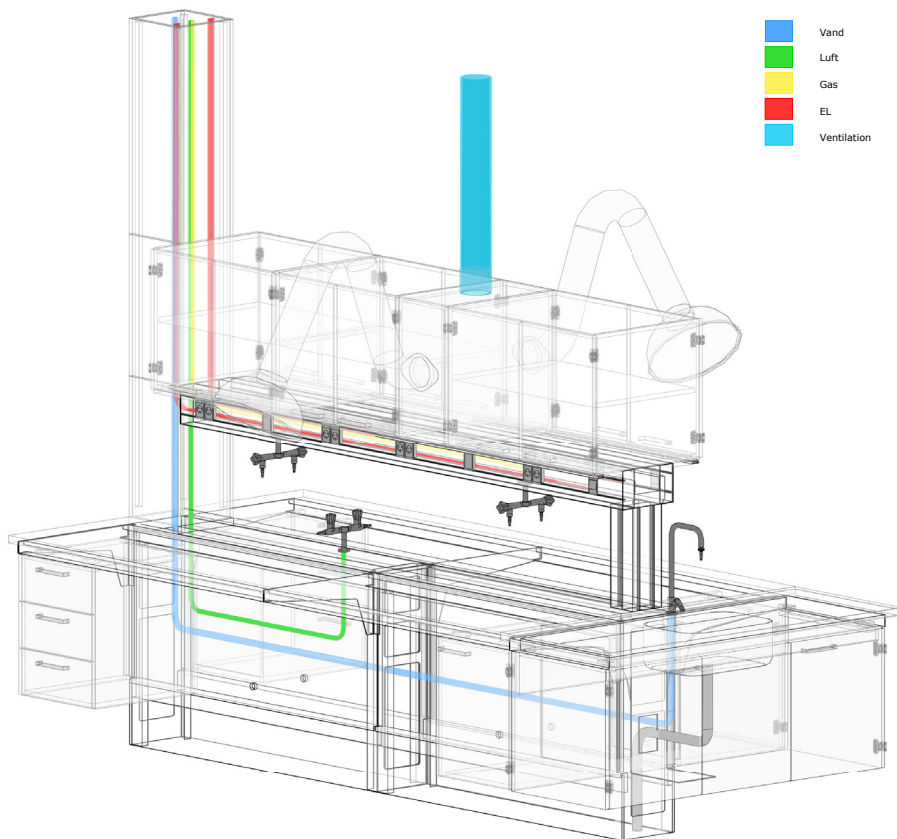

## PIPE LAYING FROM FLOOR

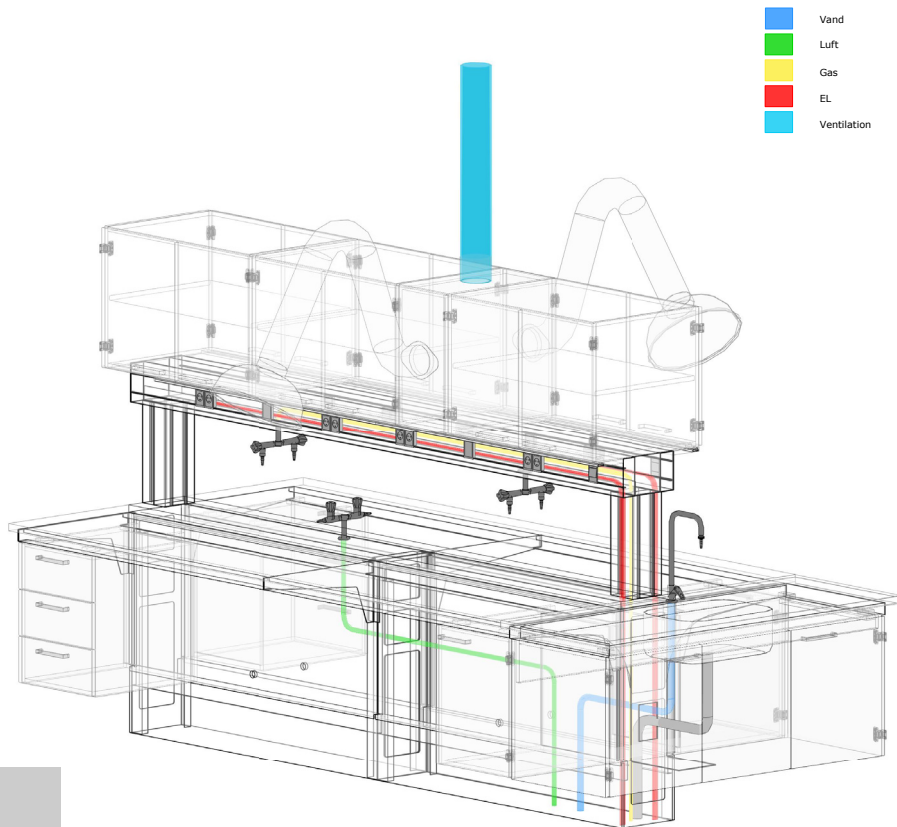

### INTERFACES

Contact Labflex for further information about interfaces.



labflex.dk

Labflex is one of Europe's largest suppliers of innovative and customer-specific furniture solutions for hospitals, laboratories and the education sector. Working in collaboration with contractors, architects and engineers – from the start of the process to the delivery of the finished interior design – Labflex creates future-proof laboratories. For more information, visit [www.labflex.dk](http://www.labflex.dk).

**HEAD OFFICE**

Labflex A/S  
Marielundvej 45 A  
2730 Herlev  
Denmark  
Tel.: +45 8747 2700

**DENMARK**

Labflex A/S  
Hjortevej 3  
7800 Skive  
Denmark  
Tel.: +45 8747 2700

**UK**

Labflex Limited  
Pegasus Business Park  
Castle Donington  
UK - DE74 2TZ  
Tel.: +44 (0) 1332 638 071